

# VICAL

Living spaces

INSTRUCCIONES DE MONTAJE

Ref:33708

## Step 1.



A: 1PC

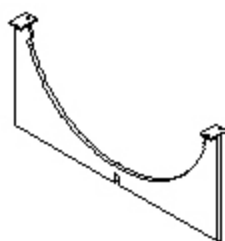

B1: 1PC

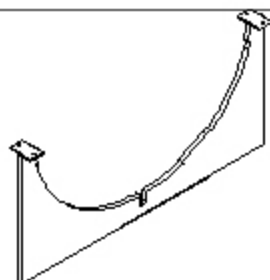

B2: 1PC

## Step 2.

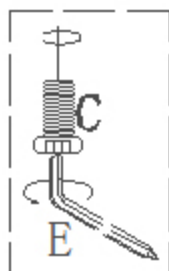
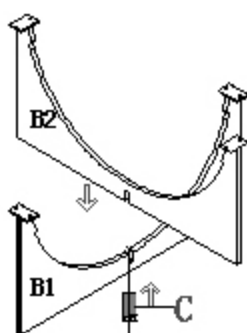

## Step 4.

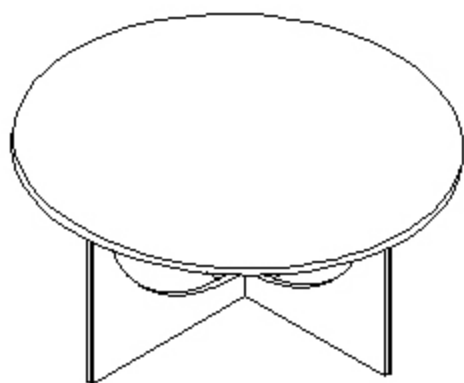

## Step 3.

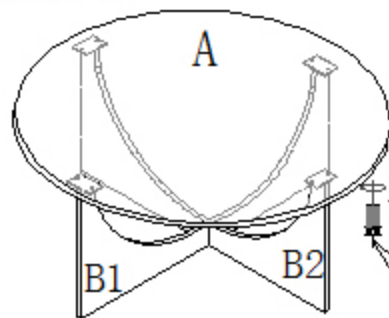

## Components:

C

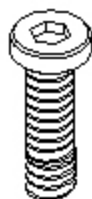

1pc

D



8pcs

E



1pc

F



1pc